

Werkzeugreihe

Zum Gebrauch als Einzelkarten, Plakat oder als Fächer.

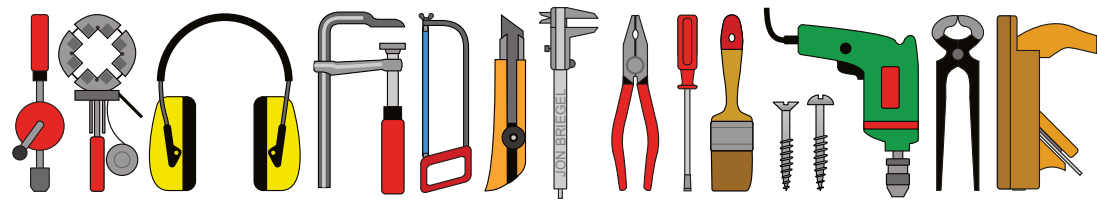

Werkzeugreihe

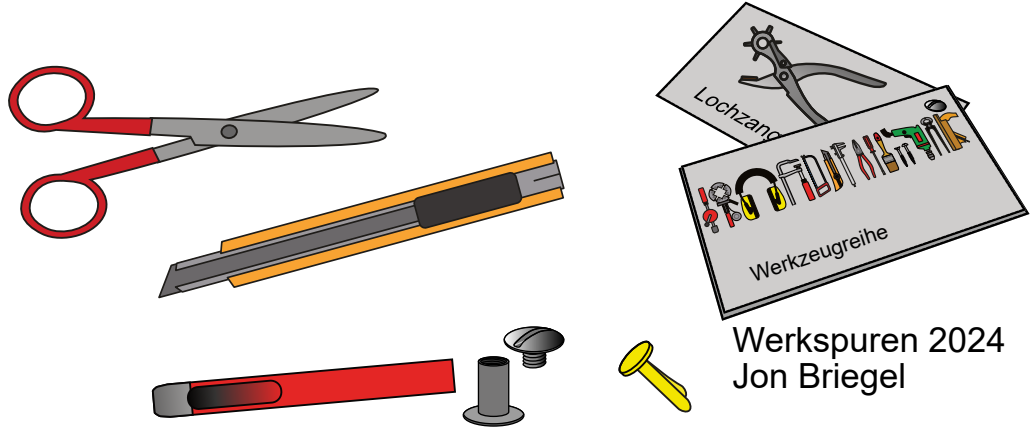
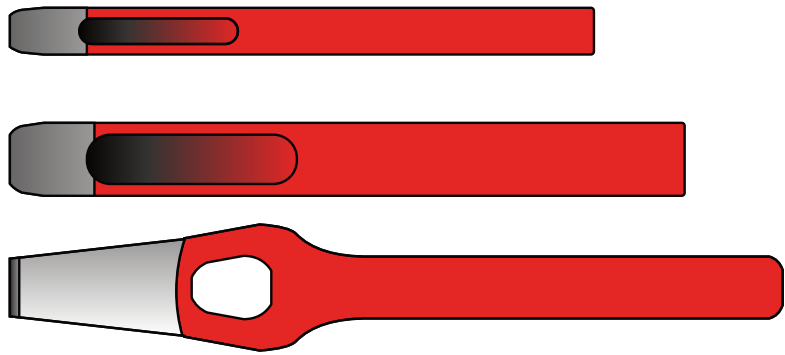

Locheisen

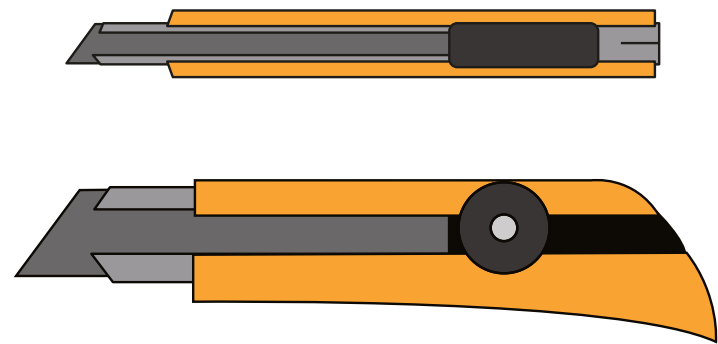

Cutter + Teppichmesser



Akku - Bohrmaschine

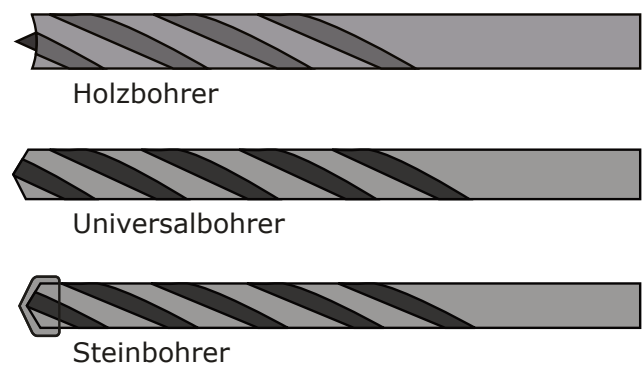

Bohrer

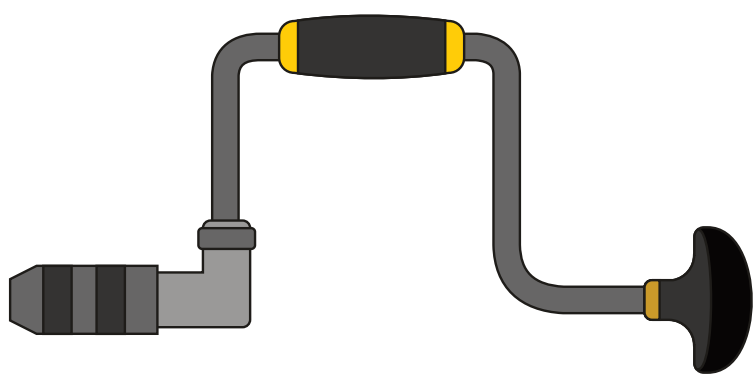

Bohrwinde

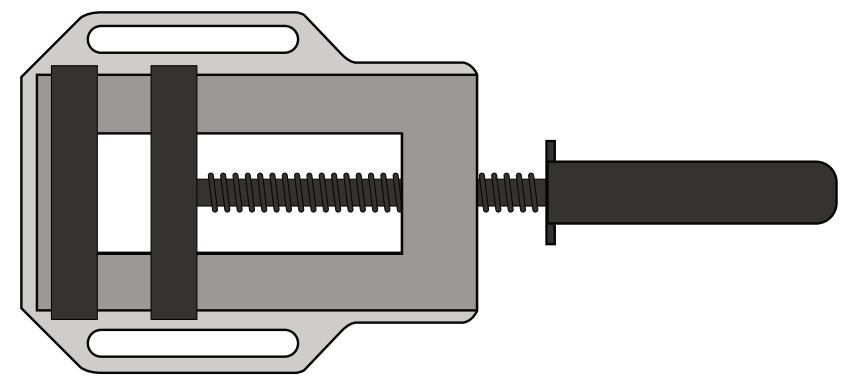

Maschinenschraubstock

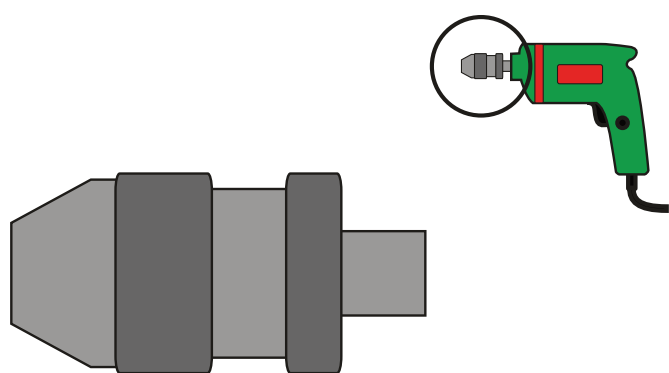

Bohrfutter

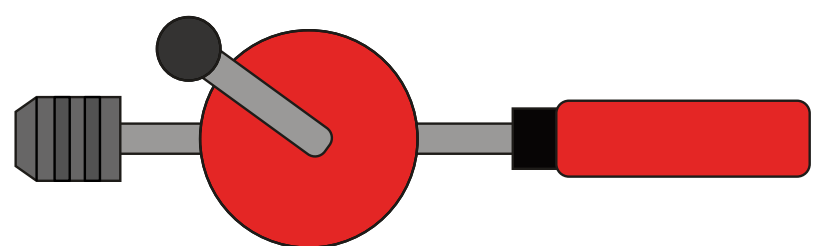

Handbohrer / Tellerbohrer

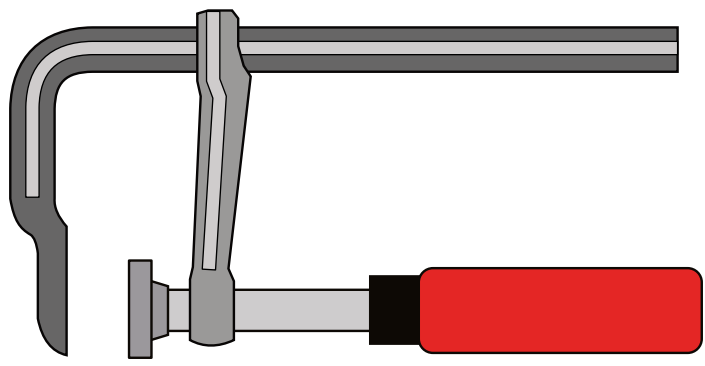

Schraubzwinde

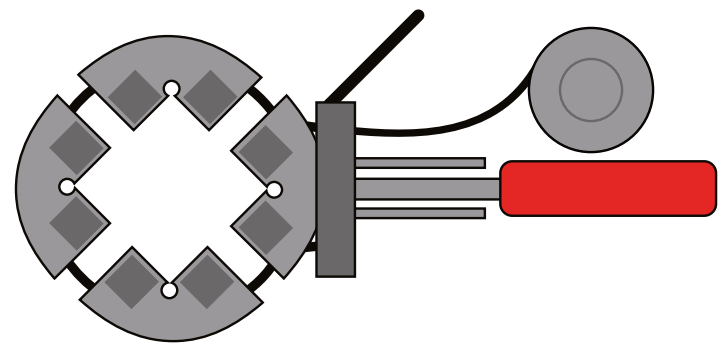

Rahmenspanner



Anschlagswinkel

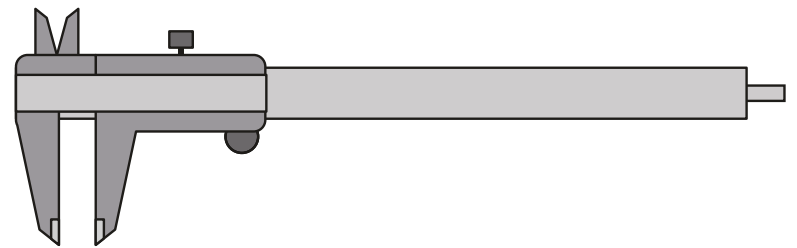

Schieblehre

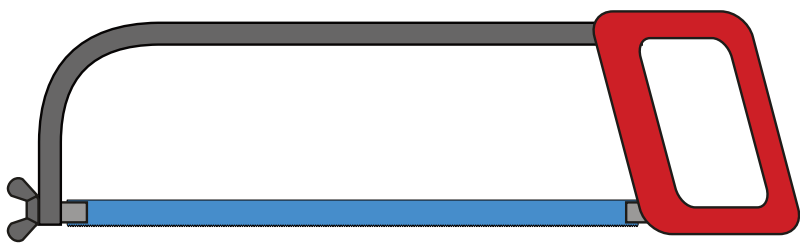

Eisensäge

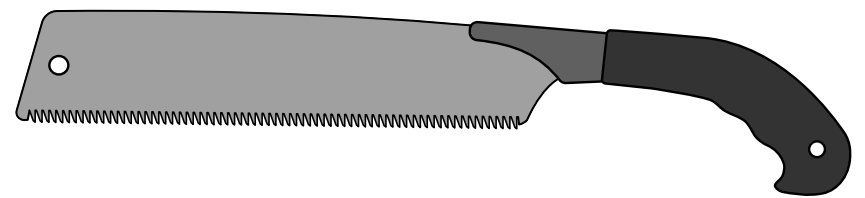

Japansäge

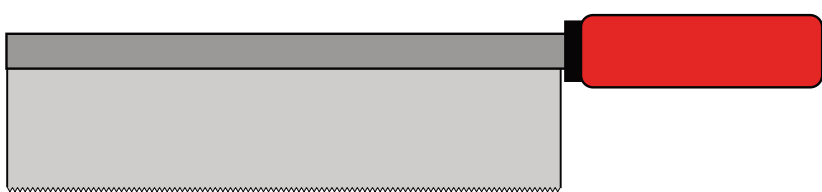

Feinsäge

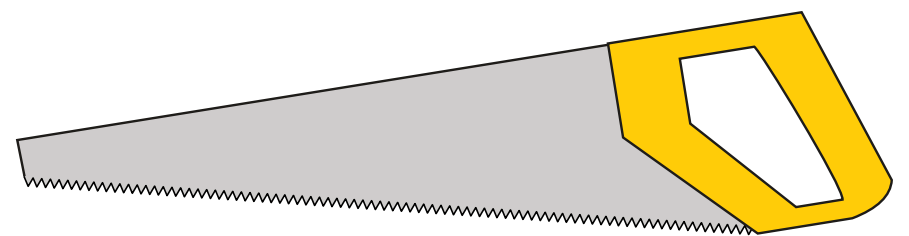

Fuchsschwanz

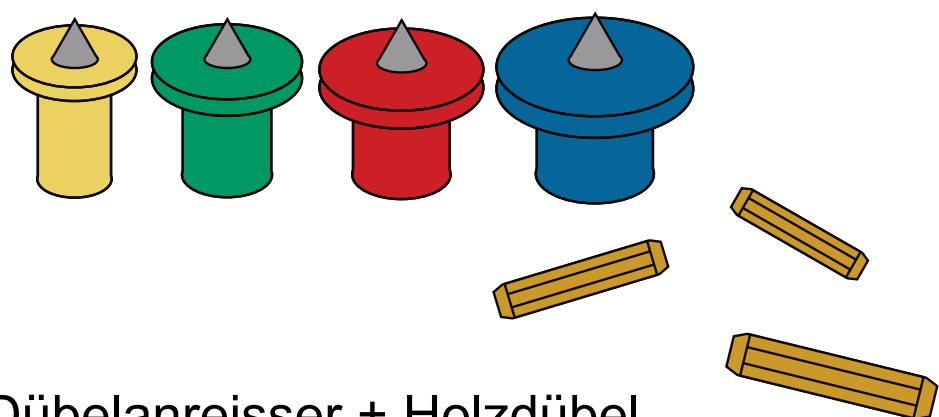

Dübelanreisser + Holzdübel

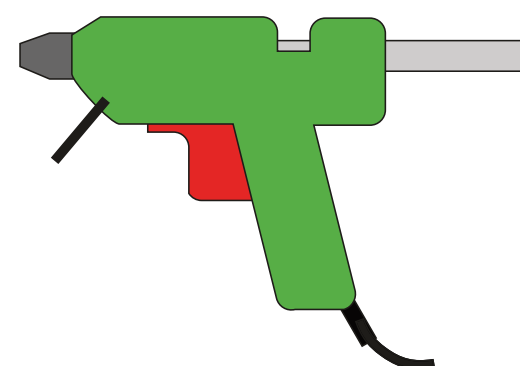

Heissleimpistole

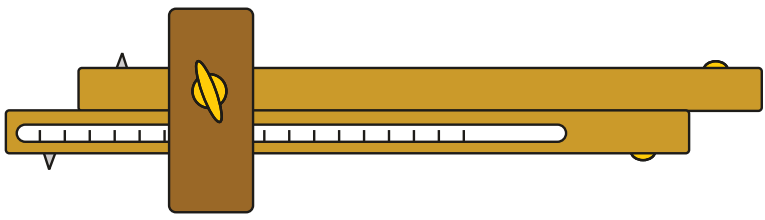

Streichmass

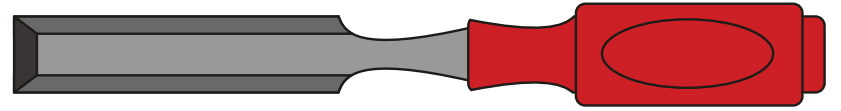

Stechbeitel

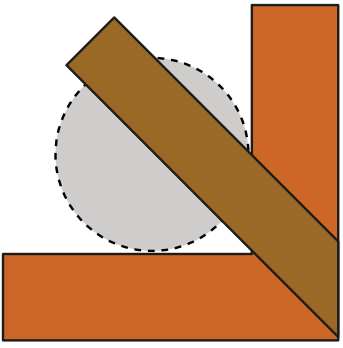

Zentrumsanreisser
um das Zentrum von einem Rad anzuzeichnen

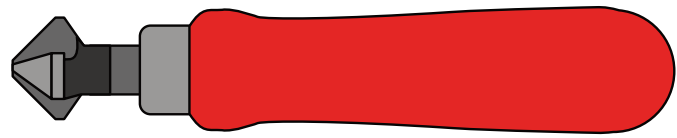

Senker
(Maschinensenker, Handsenker)

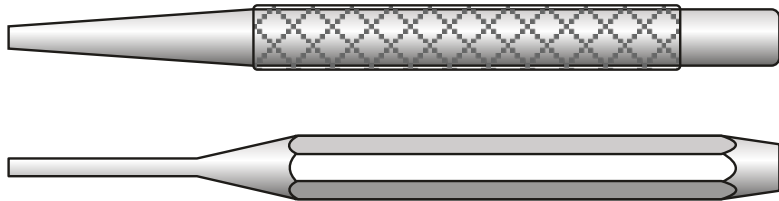

Nageltreiber, Durchschlag
z.B. um Nägel zu versenken

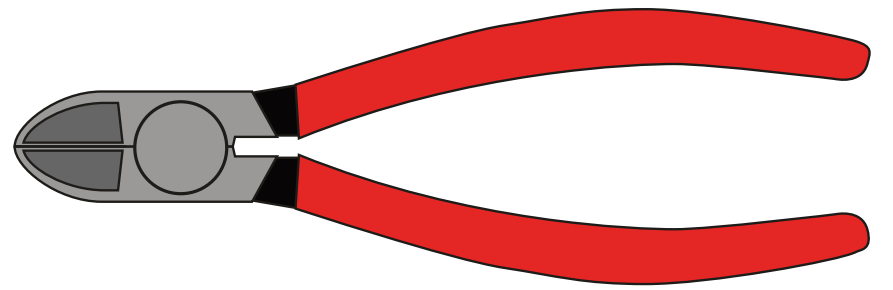

Seitenschneider
um Draht zu schneiden

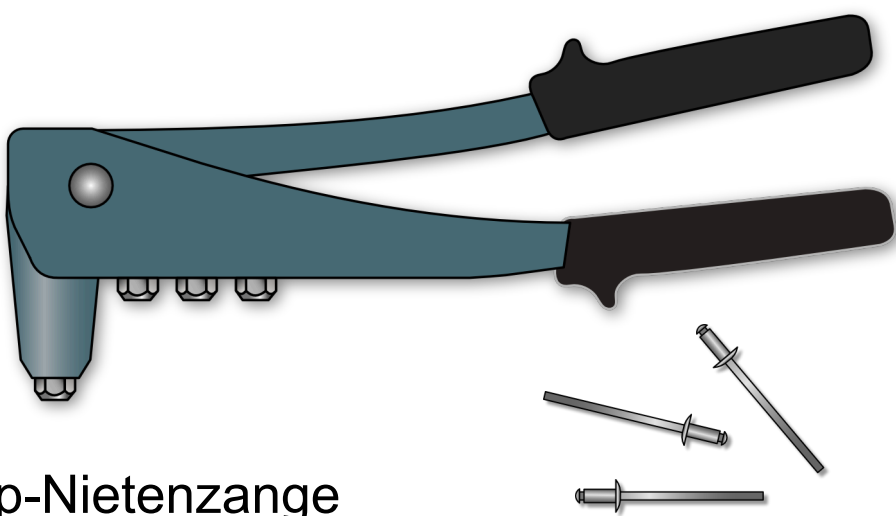

Pop-Nietenzange

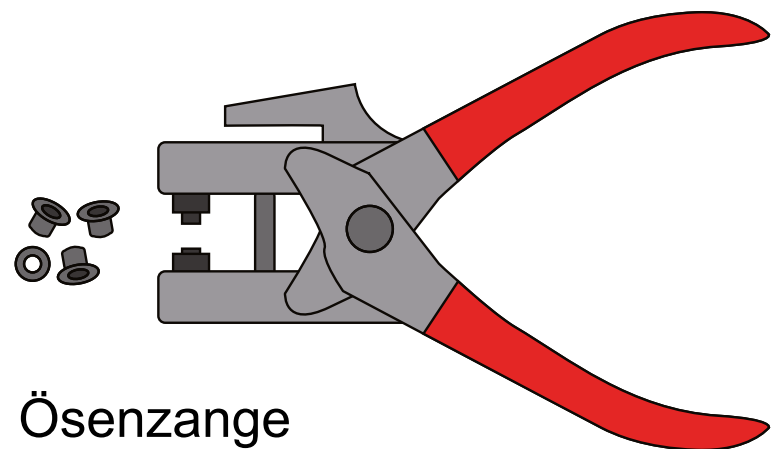

Ösenzange

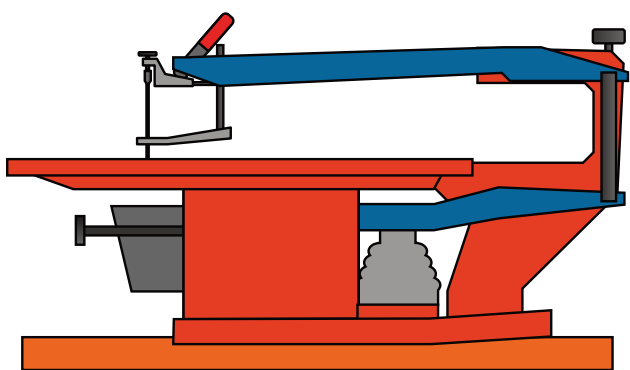

Decoupiersäge
oder elektrische Laubsäge

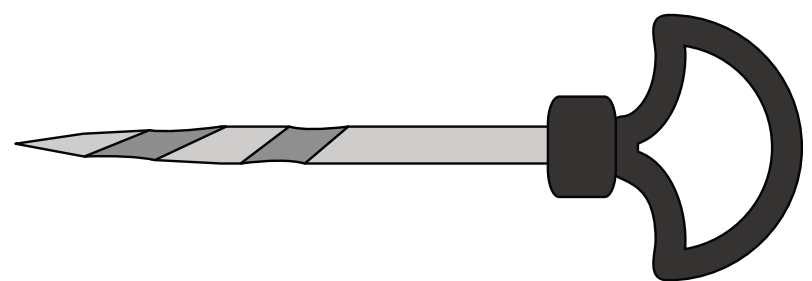

Nagelbohrer

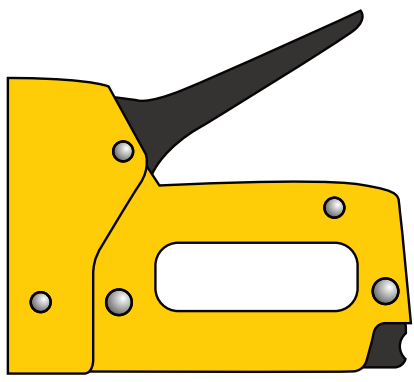

Bostitch / Tacker



Gabelschlüssel

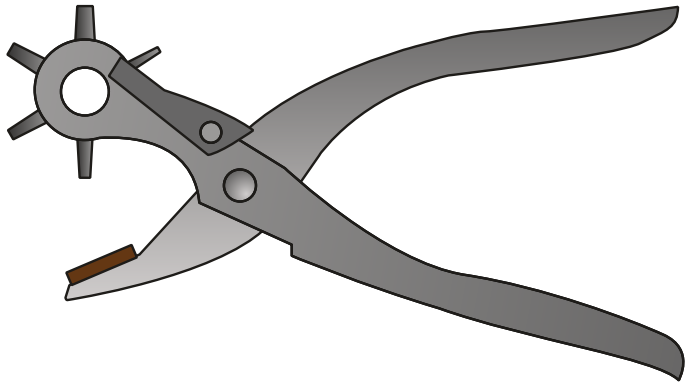

Lochzange

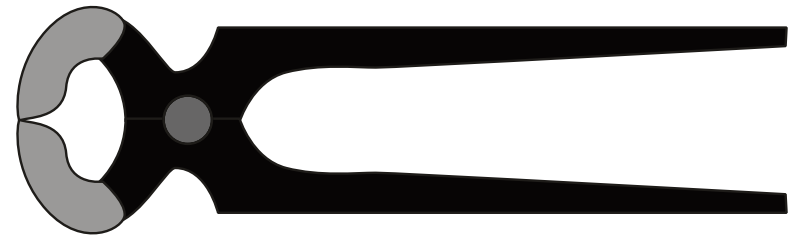

Beisszange

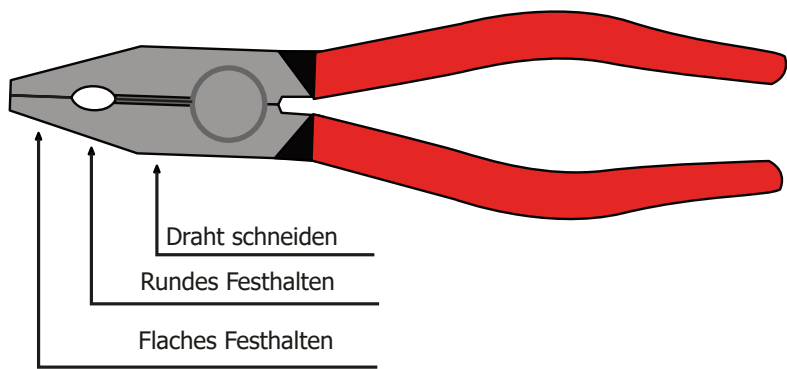

Kombizange

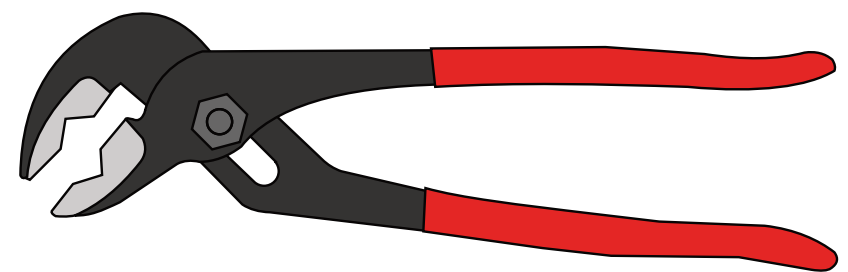

Wasserpumpenzange

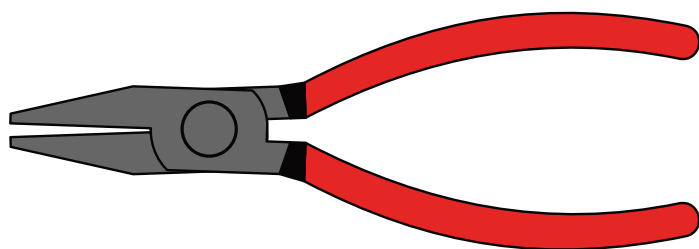

Flachzange

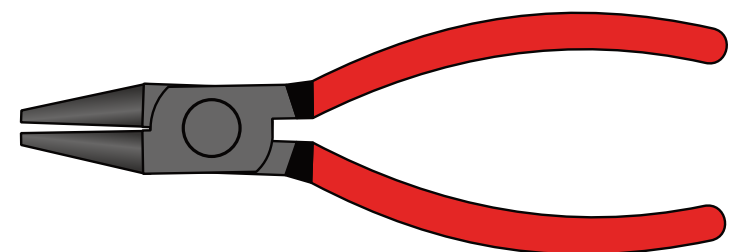

Rundzange



Inbus
... ist ein Akronym und steht für „Innensechskant Bauer und Schaurte“.

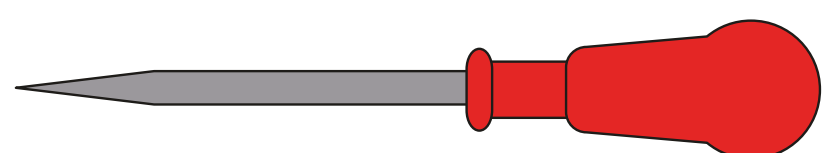

Ahle